

**POWER
WHEELS**
by Fisher-Price®

SUPER SOUND
JEEP® 4X4
ASSEMBLY MANUAL

YOUTH SERIES VEHICLE • USE TYPE H BATTERIES ONLY
FOR MODELS AO4540 / 74540-9993

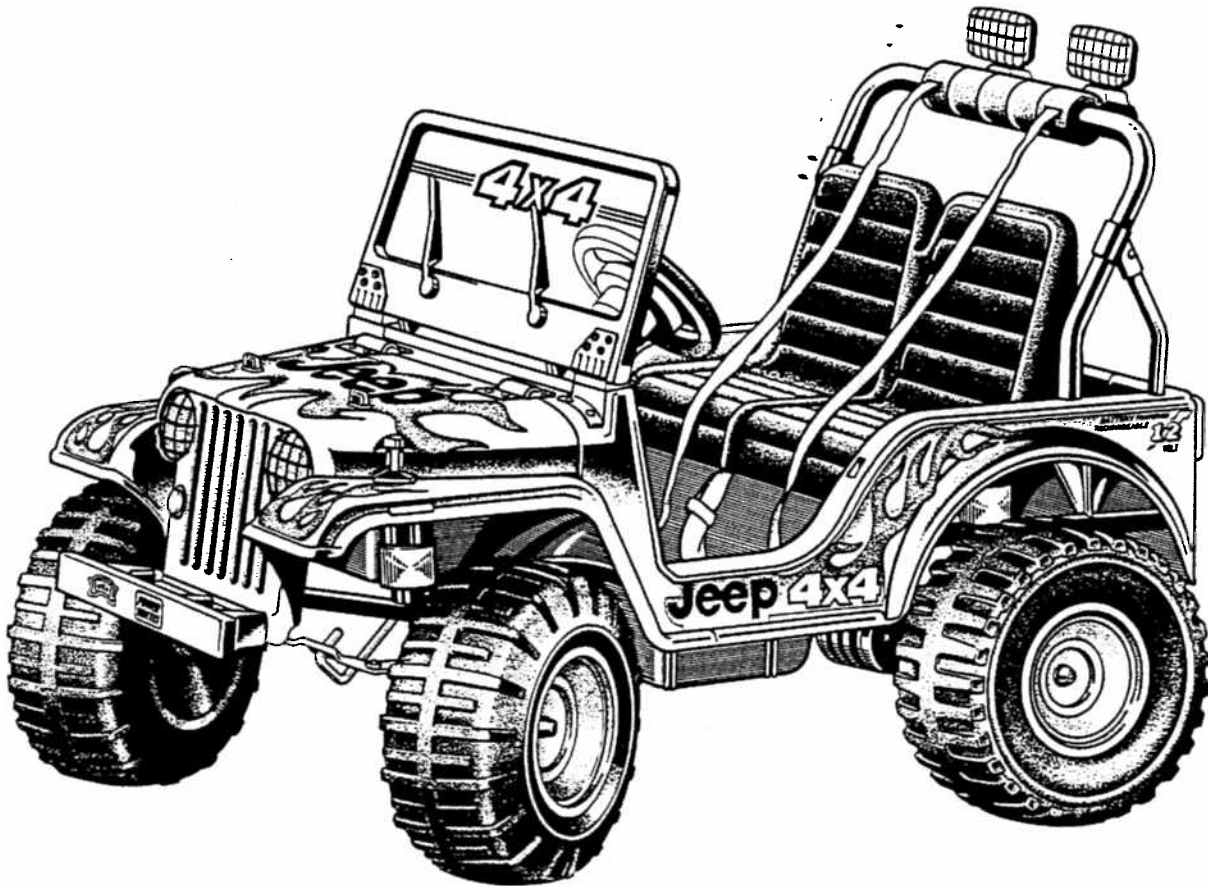

⚠ WARNING

Children can be harmed by the small parts, sharp edges and sharp points in the unassembled state, or by electrical items. Care should be taken in unpacking and assembly of the vehicle. Children should NOT handle parts, batteries, or help in assembly.

POWER WHEELS® HAS THE MOST COMPREHENSIVE SERVICE PROGRAM IN THE TOY INDUSTRY

TOLL-FREE SERVICE LINES

- Multi (twenty-five) service lines, open from 8:00 AM to 7:00 PM Monday through Friday and Saturday, 9:00 AM to 5:00 PM

1-800-348-0751

- ¿Habla Español? Si usted tiene alguna pregunta ó necesita asistencia llame gratis 1-800-348-0751 para los Estados Unidos.

A NATIONAL SERVICE CENTER NETWORK

- Over 300 service centers nationwide
- Our service centers will repair or replace parts under warranty at no charge
- For vehicles beyond warranty, our service centers will perform repairs for a minimal charge

IMPORTANT BATTERY INFORMATION

ALWAYS CHARGE THE BATTERIES A FULL 18 HOURS THE FIRST TIME. AFTER THAT, RECHARGE FOR 14 HOURS.

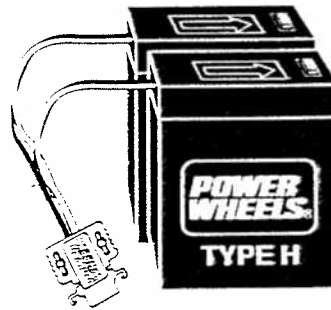

THIS VEHICLE USES A POWER WHEELS® TYPE H BATTERY AND A POWER WHEELS TYPE H CHARGER ONLY. NO OTHER TYPE WILL WORK. Even with proper care, the rechargeable battery will not last forever. The replacement battery must be a Type H battery.

To purchase, contact:

- Dealer where your vehicle was purchased.
- Authorized Service Center (See Authorized Service Center list).
- Power Wheels Customer Service 1-800-348-0751

IMPORTANT

In the unlikely event that any of the parts are missing or damaged, contact customer service 1-800-348-0751.

TOOLS NEEDED (NOT INCLUDED)

PHILLIPS
SCREWDRIVER



HAMMER



LARGE PARTS BAG

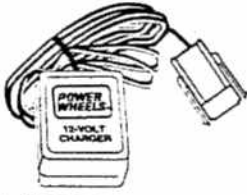

12-VOLT CHARGER



*HOOD LATCH (2)



GAS CAP/FLANGE
ASSEMBLY

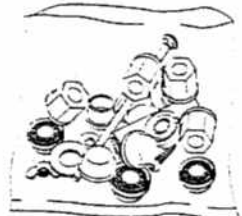

SMALL PARTS BAG

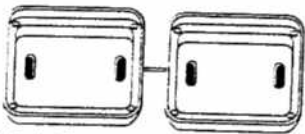

TAILLIGHT HOUSING SET



BATTERY RETAINER

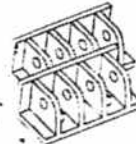

*WINDSHIELD
HINGE SET



LIGHT-BAR
SUPPORTS (2)



*MICROPHONE

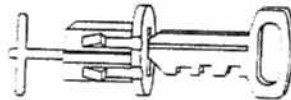

*KEY/KEY HOUSING

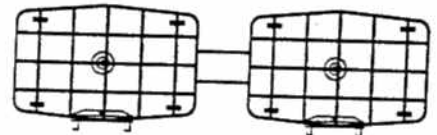

KC® LIGHT/GUARD ASSEMBLY



SEAT BELT

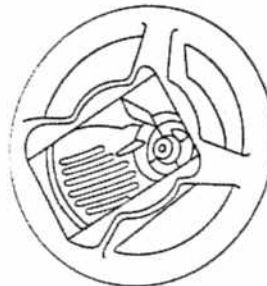

STEERING WHEEL

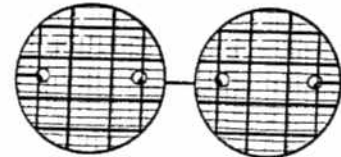

*HEADLIGHT/GUARD
ASSEMBLY

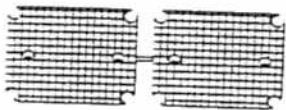

*TAILLIGHT LENS SET

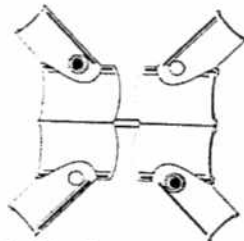

LIGHT-BAR BRACKET SET

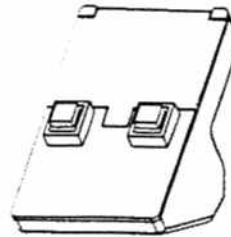

SOUND BOX



STEERING WHEEL
PLATE

NOT SHOWN:
LITERATURE BAG

*THESE ITEMS MAY
ALREADY BE
ASSEMBLED OR
FOUND IN THE
SMALL PARTS BAG

SMALL PARTS BAG

CAUTION: NEVER LEAVE THESE PARTS IN THE PRESENCE OF SMALL CHILDREN

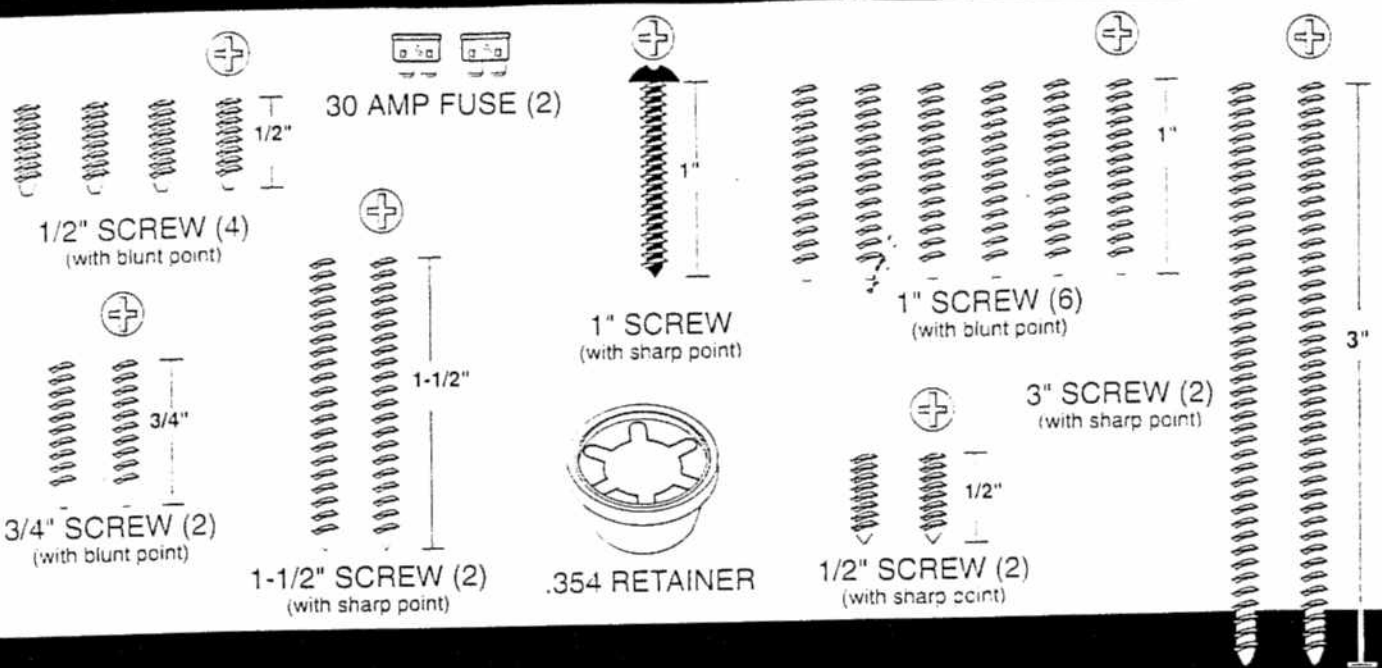

ADDITIONAL ITEMS

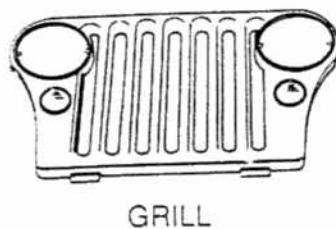
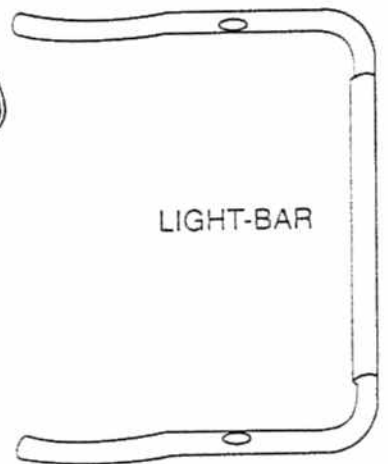
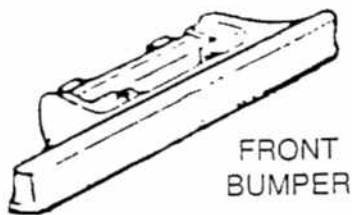
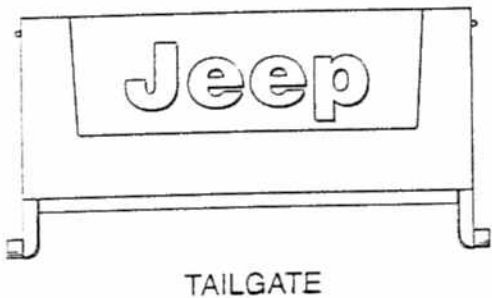
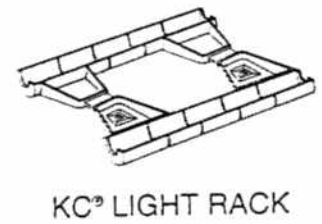
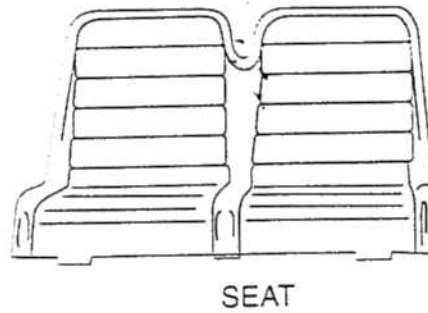
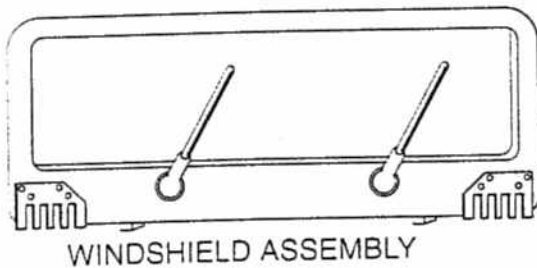

NOT SHOWN:
DECAL SHEETS
BATTERY (2)

A

BATTERY CHARGING

FOLLOW EACH STEP CAREFULLY

It is important that you use only Power Wheels® Type H batteries.

These batteries have the correct plug connectors and dimensions necessary for proper battery compartment fit.

For more information on these 6-volt Type H batteries, please refer to your Owner's Manual.

ASSEMBLY
BY

**ADULTS
ONLY**

DO NOT
OMIT ANY
STEPS

1

REMOVE batteries from package.
INSERT fuses into batteries.

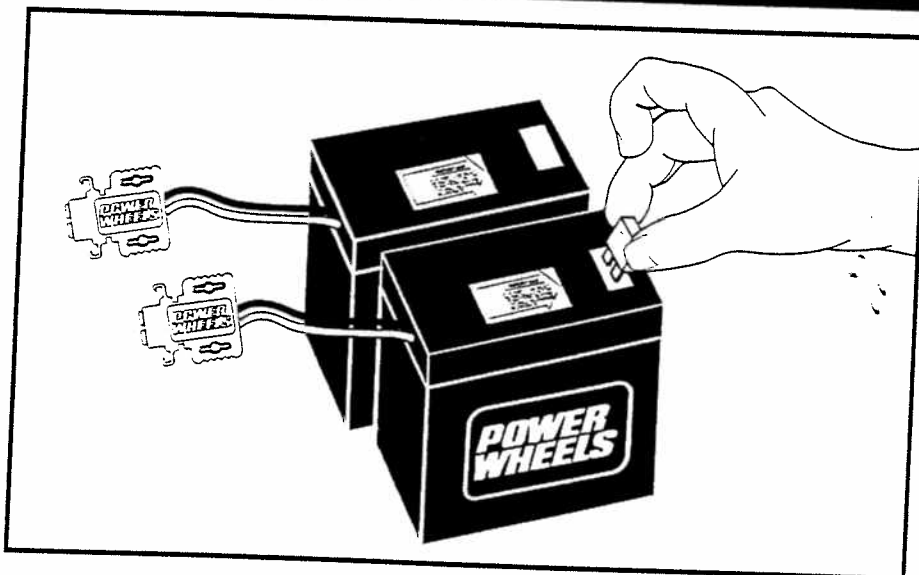

2

STACK one battery connector on top of the other and snap together.

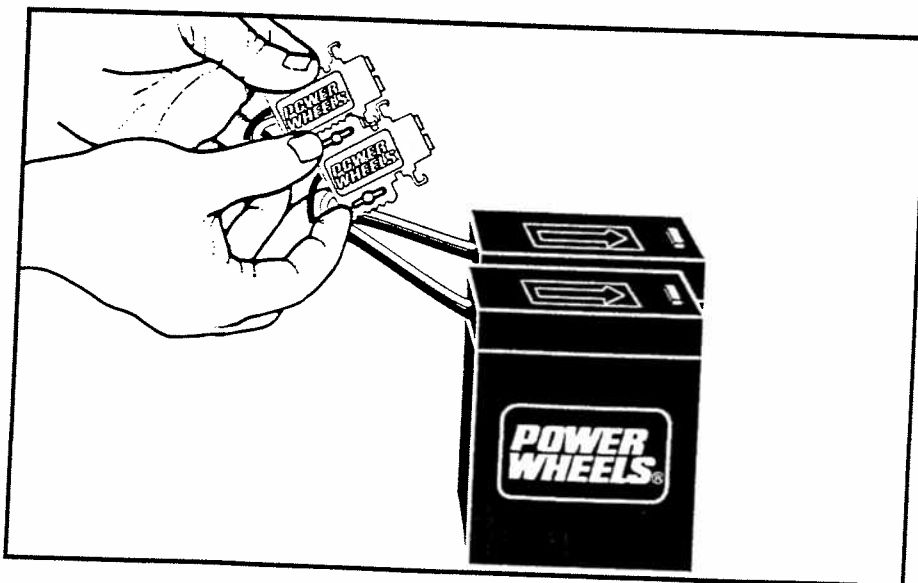

3

Your vehicle has the Power Wheels® Lock-In™ connectors. SQUEEZE tabs on charger and push into battery connectors to lock in. (To disconnect, simply squeeze tabs and pull.)

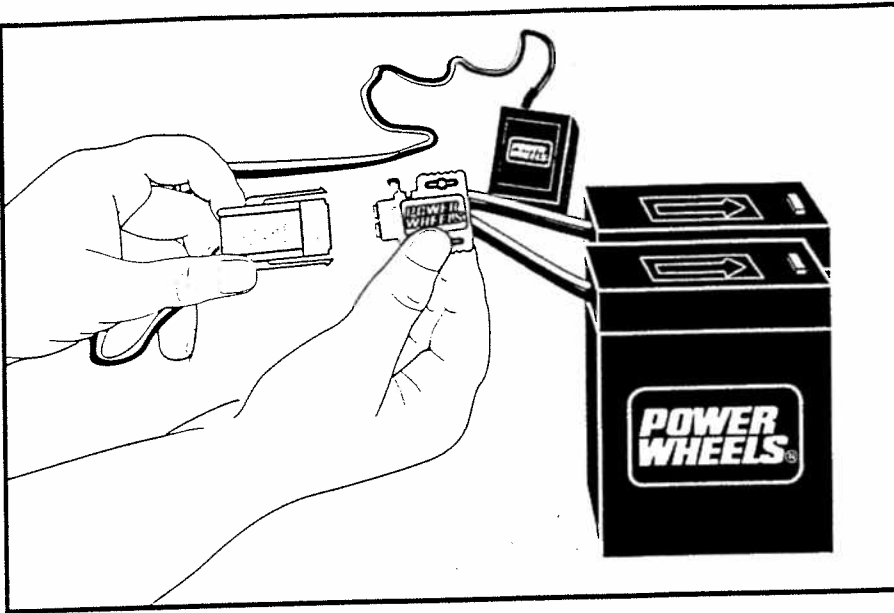

4

PLUG battery charger into wall outlet. CHARGE batteries for a minimum of 18 hours for the first charge. (After that, 14 hours is enough.) Power Wheels® recommends not charging over 30 hours.

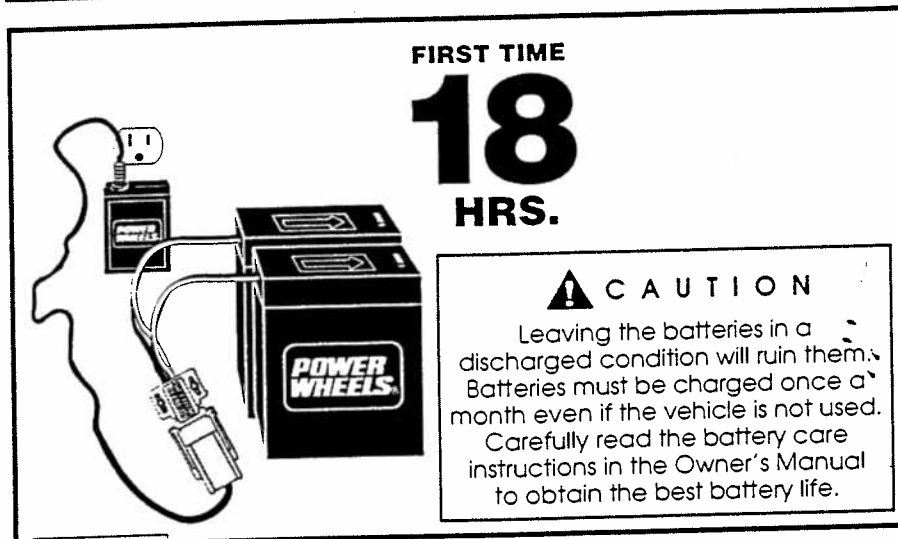

FIRST TIME

18

HRS.

CAUTION

Leaving the batteries in a discharged condition will ruin them. Batteries must be charged once a month even if the vehicle is not used. Carefully read the battery care instructions in the Owner's Manual to obtain the best battery life.

B

STEERING COLUMN / STEERING WHEEL

1

TURN vehicle upside down. SLIDE steering column through holes in underside of body and through hole in top of body.

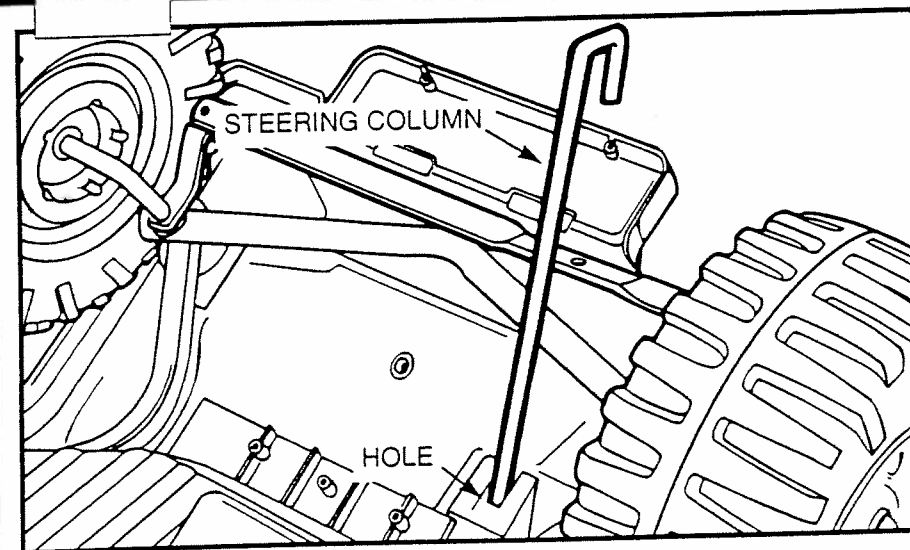

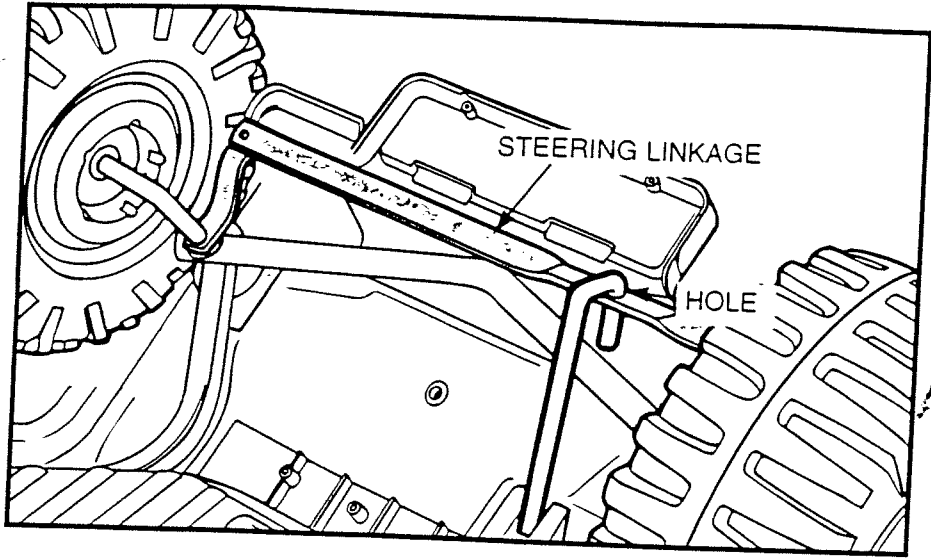

2

INSERT curved end of steering column through hole in steering linkage.

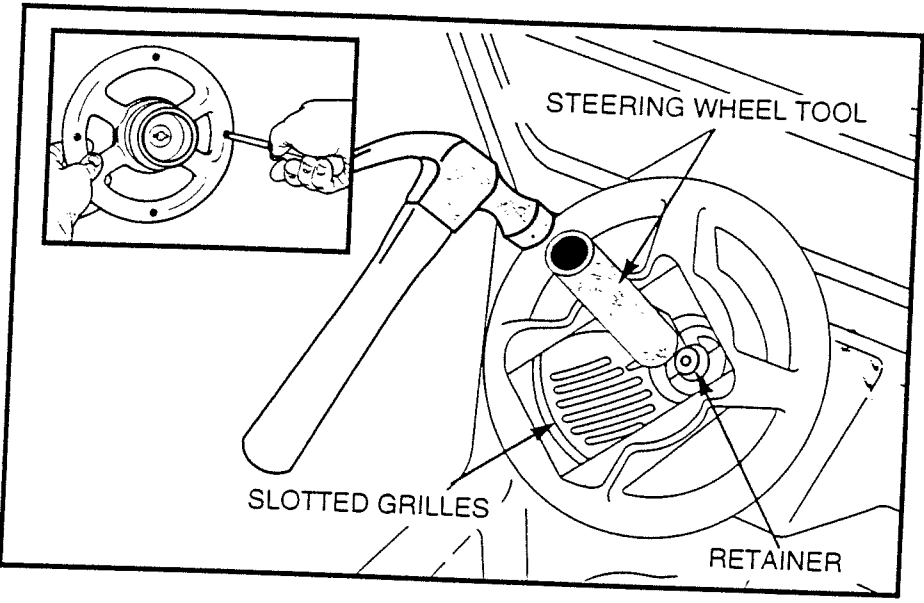

3

Insert two 1/2" screws (with sharp points) into holes.

SUPPORT steering column under vehicle.
 PLACE steering wheel onto steering column.
 NOTE: Slotted grilles of steering wheel must be facing downwards.
 PLACE retainer onto steering column.
 HAMMER retainer secure using steering wheel tool.

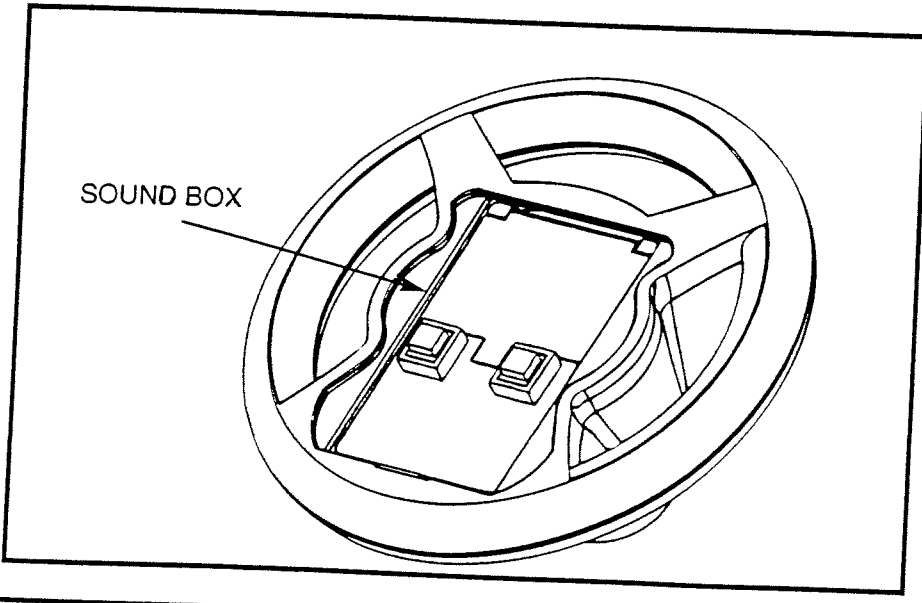

4

INSTALL three batteries into sound box.
 (Batteries Not Included)

KEEP THESE BATTERIES AND OTHER SMALL PARTS AWAY FROM CHILDREN.

DROP sound box into steering wheel.

5

SNAP steering wheel cover onto steering wheel.

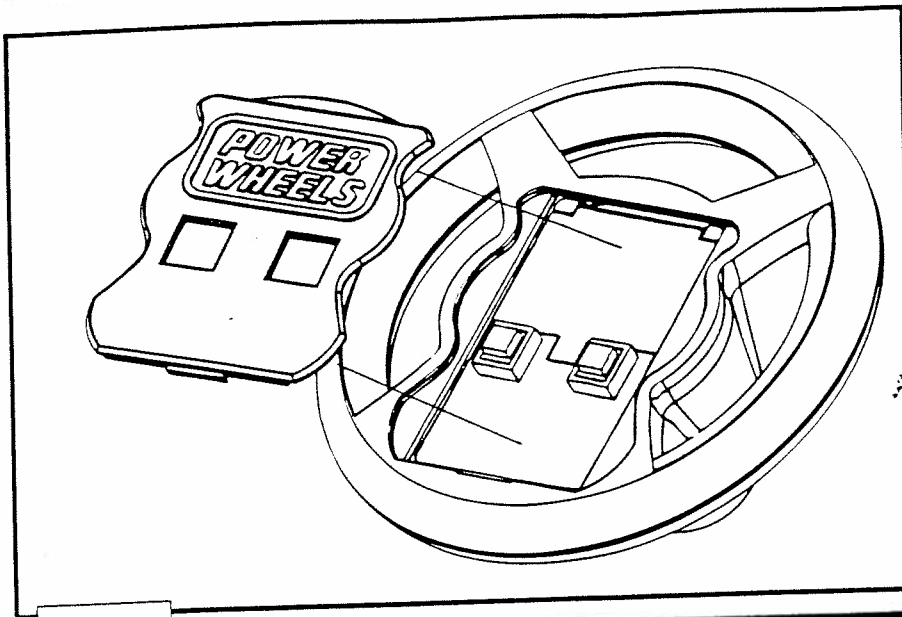

C

LIGHT-BAR / SEAT BELT INSTALLATION

1

INSERT plastic clip on end of each seat belt into the body. PULL back to lock in place.

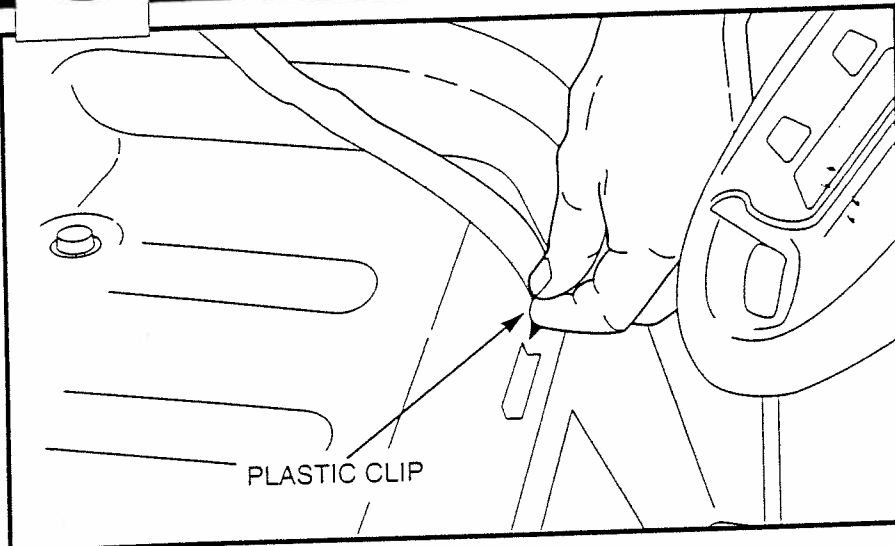

2

SLIDE both loops of seat belts onto light-bar.

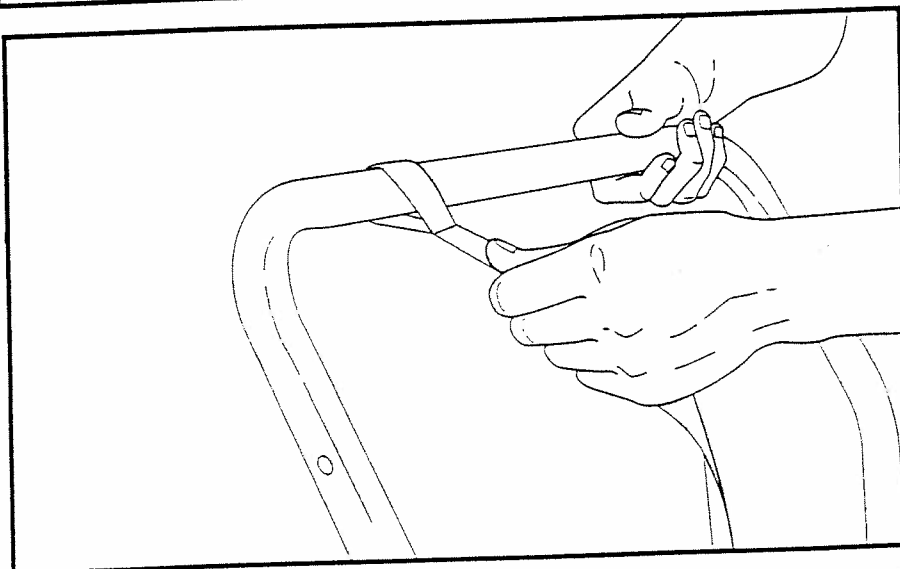

3

PLACE light-bar into holes in rear of body. (The light-bar should slant toward the rear of the vehicle.)

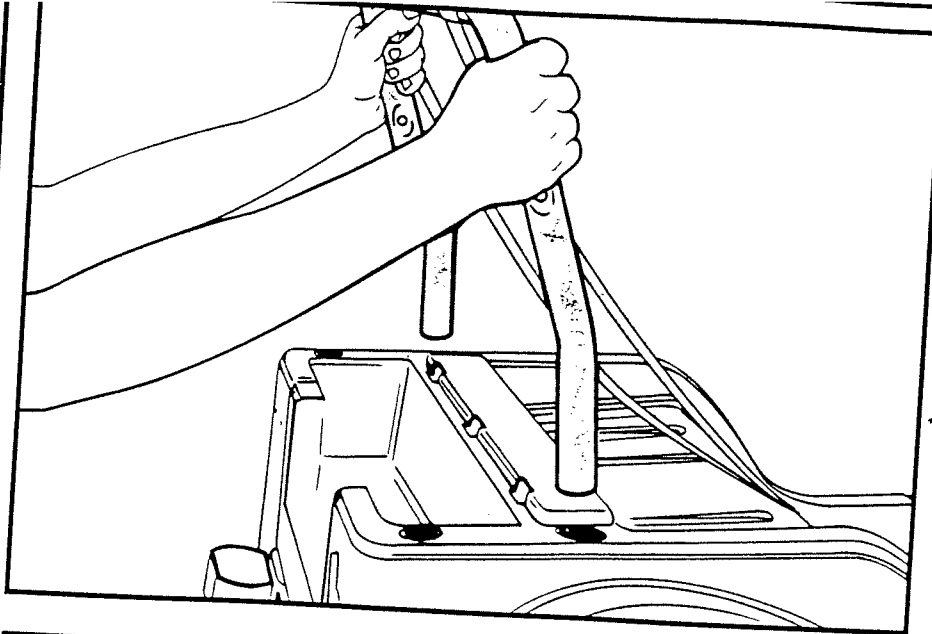

4

INSERT light-bar support tube.
PLACE light-bar brackets on both the light-bar and support tube.

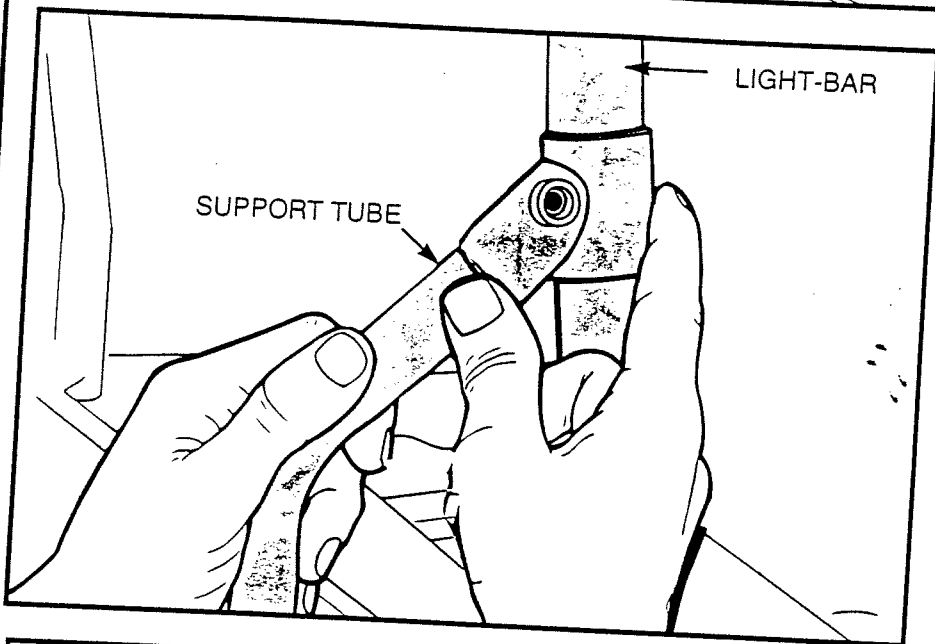

5

INSERT 1" screw into each bracket.
TIGHTEN.
REPEAT for other side.

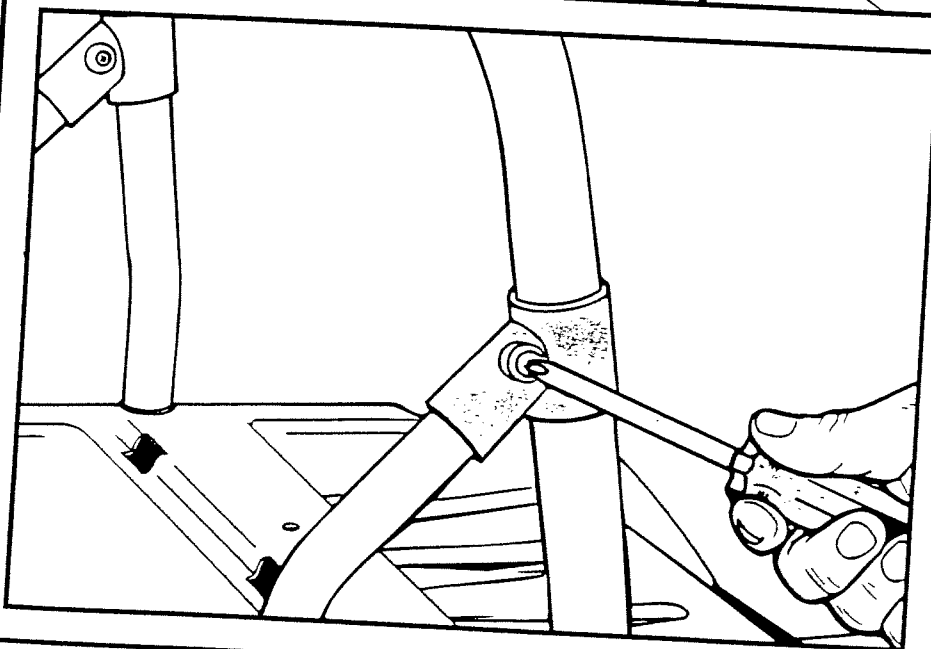

6

SLIP seat belt into slots in light rack.
PLACE KC® light rack onto light-bar.

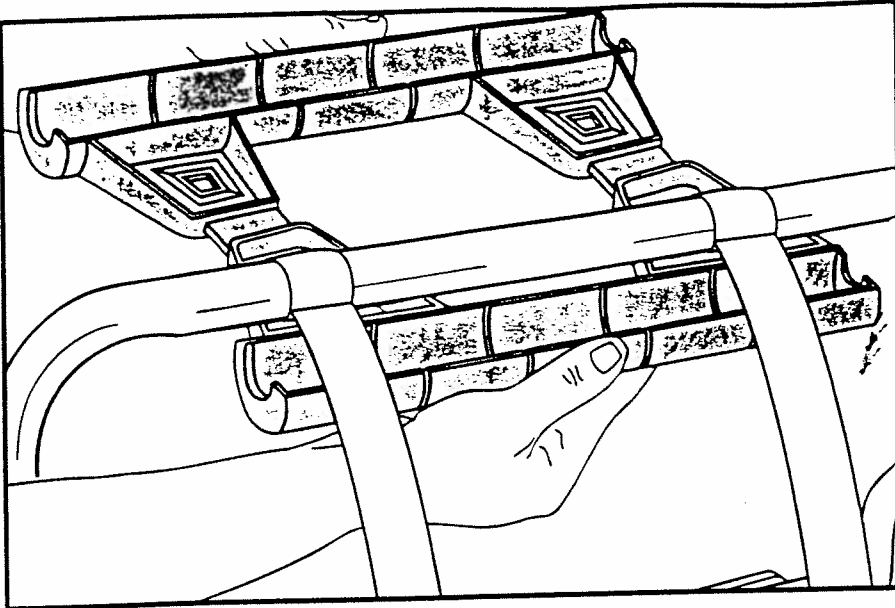

7

INSERT 1-1/2" screw into underside of light rack.
TIGHTEN.
REPEAT for other side.

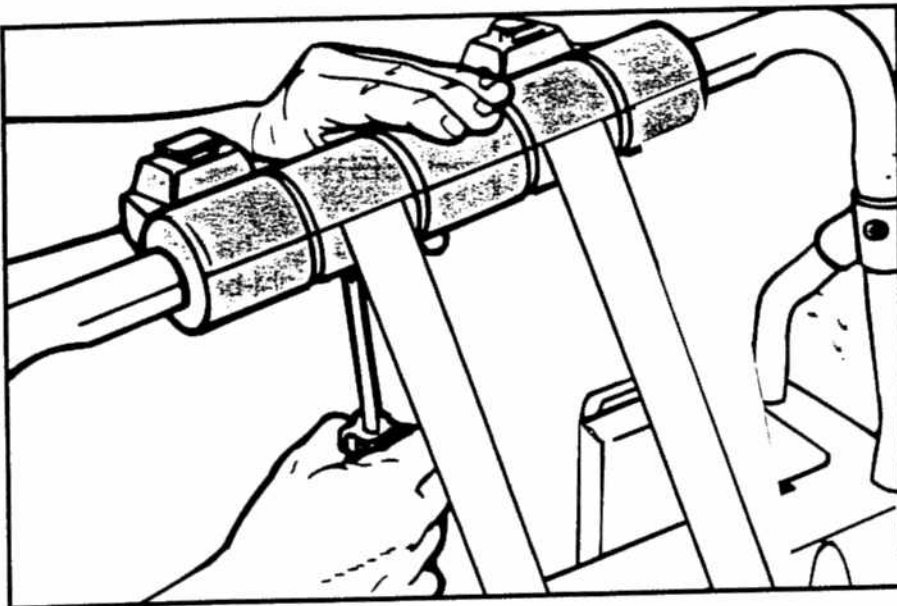

8

DISSASSEMBLE KC® LIGHT/GUARD ASSEMBLY.
SLIDE KC light back onto rack.

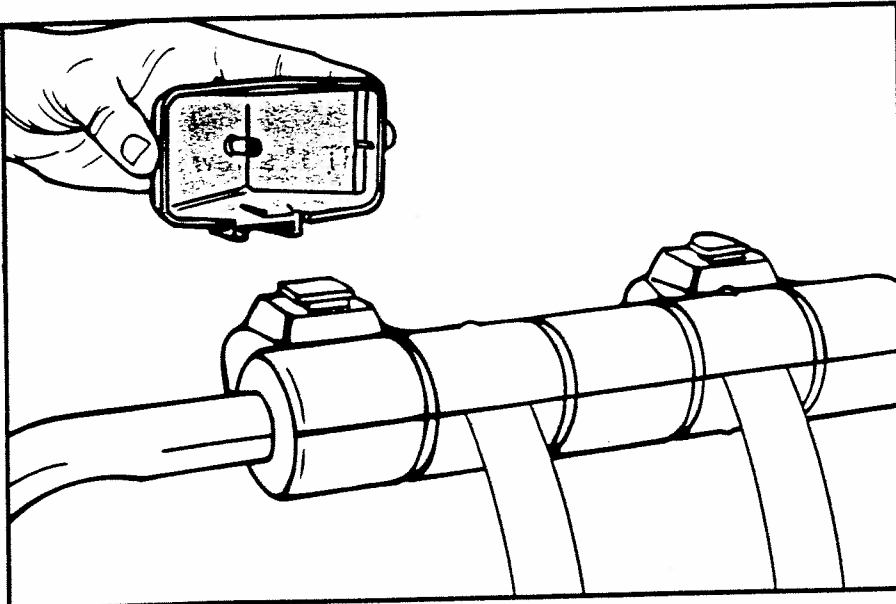

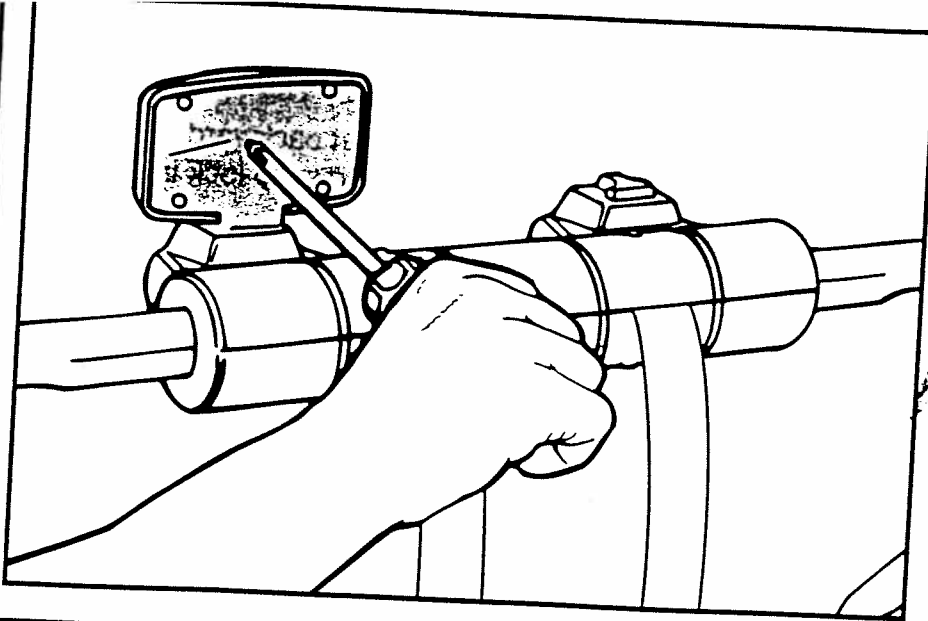

9

PLACE KC light front onto light back.
 INSERT 1/2" screw with sharp point.
 TIGHTEN.

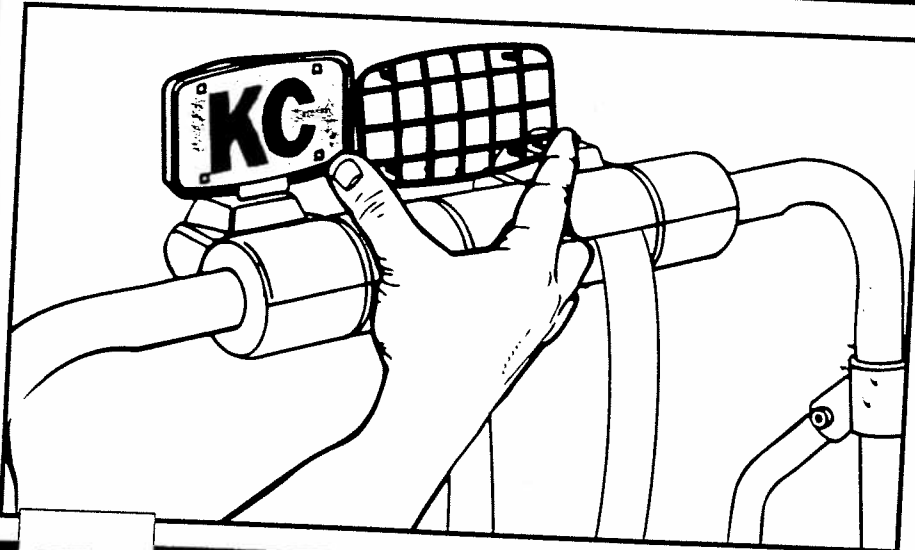

10

APPLY KC LIGHT® DECAL BEFORE THIS STEP.
 SNAP KC light guard onto light.
 REPEAT for other side.

D

SEAT / REAR BUMPER

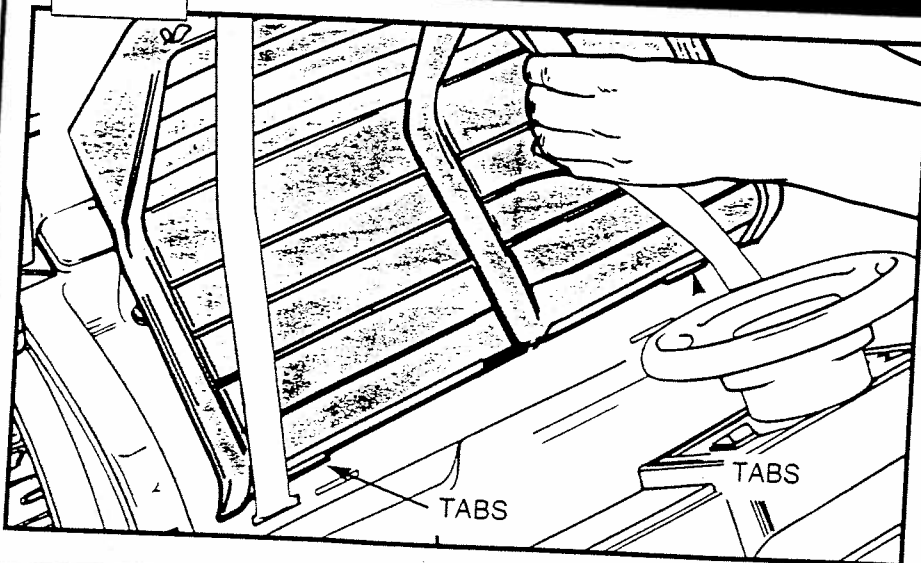

1

SLIDE seat under seat belts.
 INSERT tabs on front of seat into slots in body.

2

TILT seat backward.
PUSH down to lock into
place.

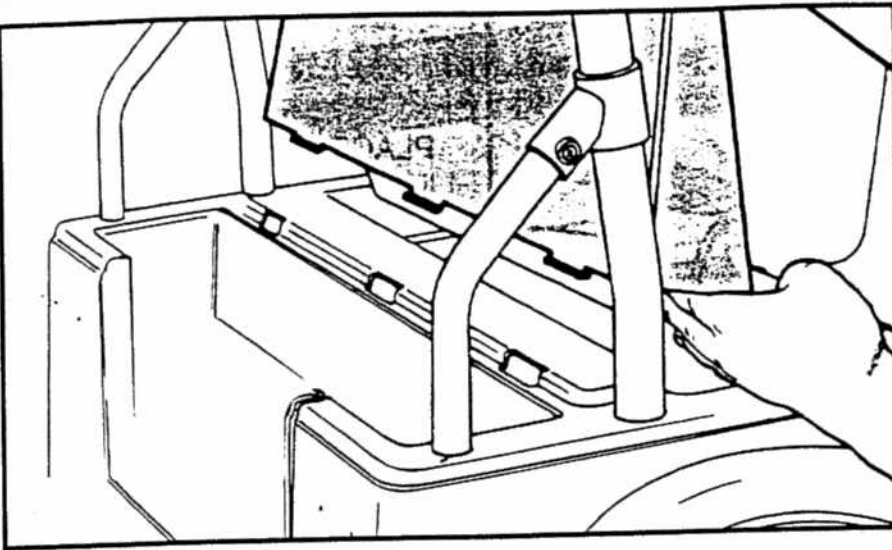

3

INSERT tabs on rear bumper
into slots in body.
PRESS to snap into place.

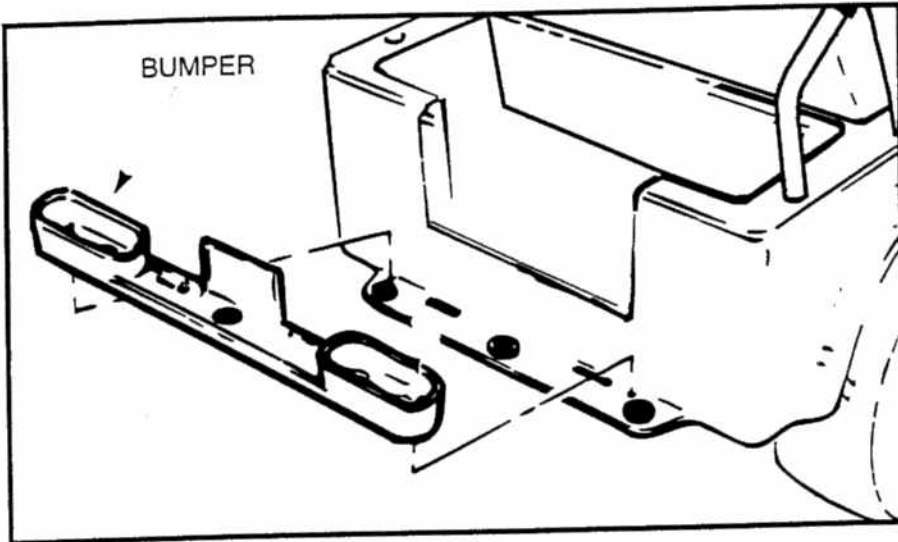

E

TAILLIGHTS / GAS CAP / TAILGATE

1

ASSEMBLE taillight lenses
and holders.

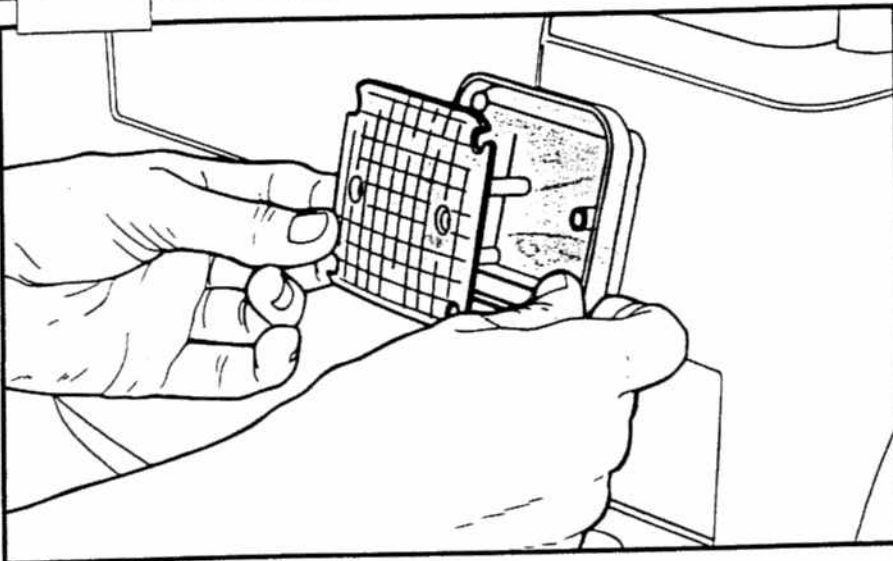

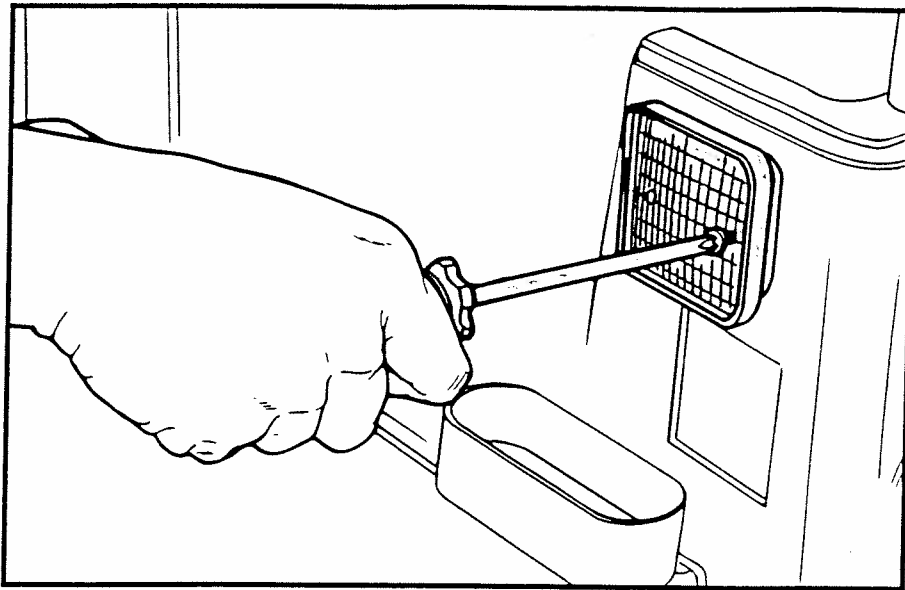

2

INSERT two 1" screws through assembly into body. TIGHTEN. REPEAT for other side.

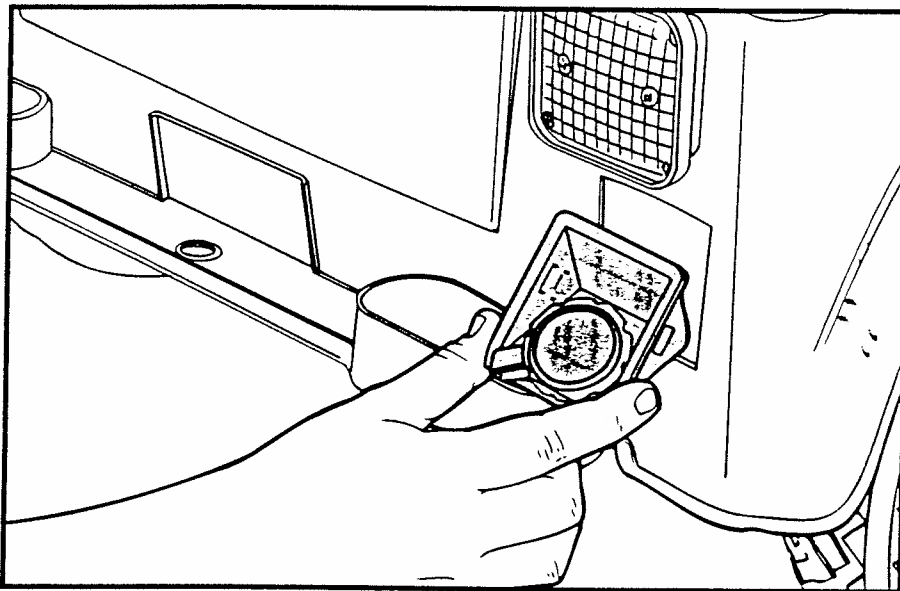

3

SNAP gas cap/flange assembly into place as shown.

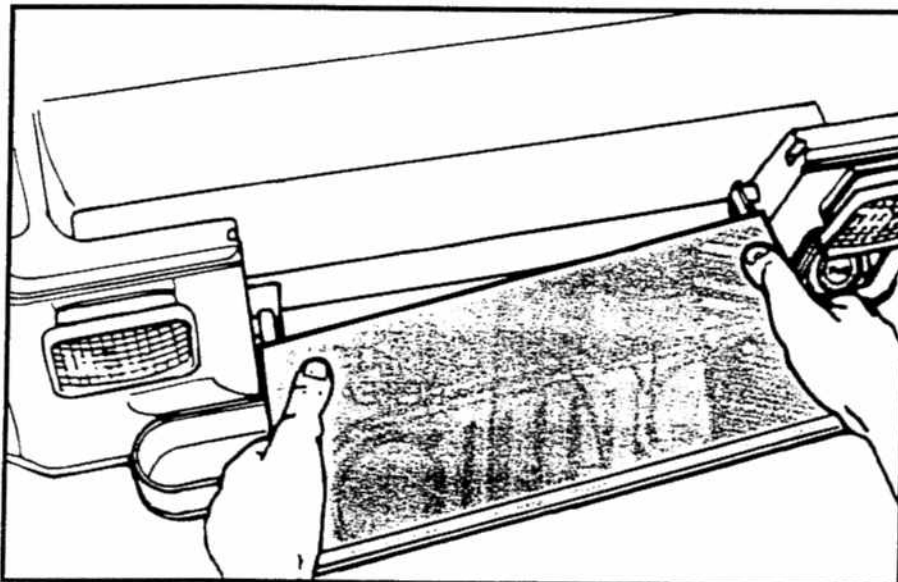

4

POSITION left side of tailgate into hole in body. SLIDE right side into place.

F

WINDSHIELD

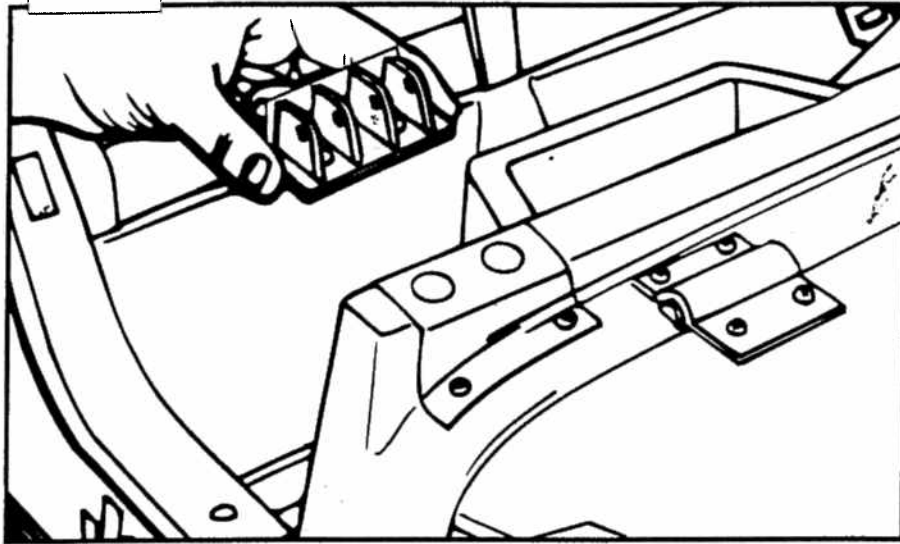

1

PLACE windshield hinge into position, with open side facing front.

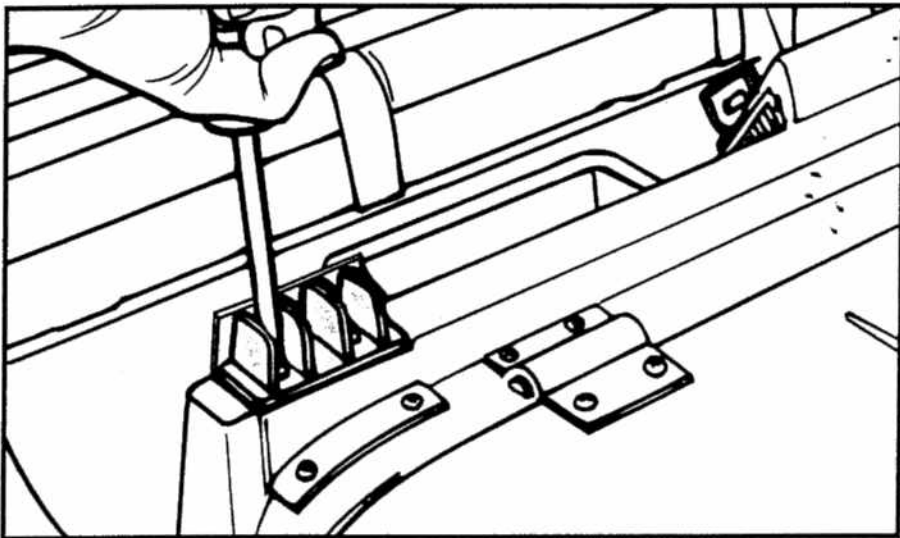

2

INSERT two 1/2" screws with blunt point into hinge. TIGHTEN. REPEAT for other side.

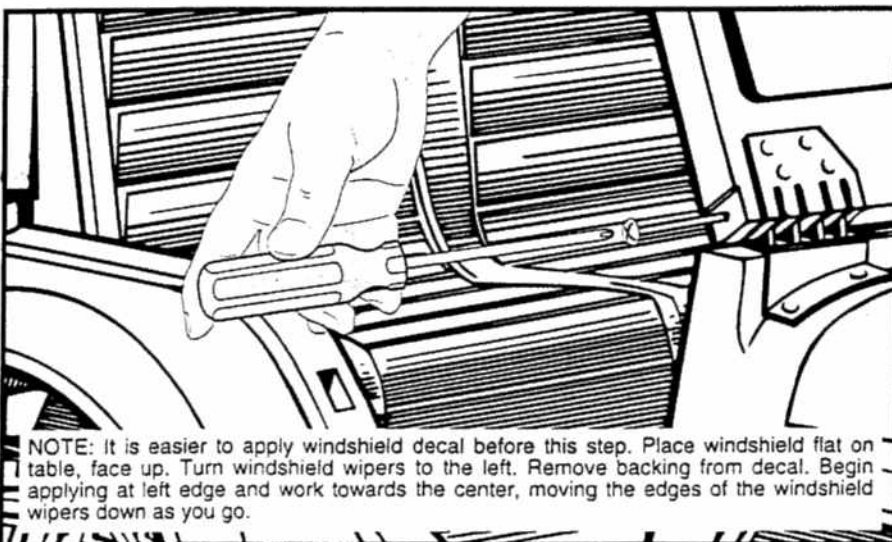

3

ALIGN holes in windshield with holes in hinges. PLACE 3" screw through holes in windshield and hinge. TIGHTEN. REPEAT for other side.

NOTE: It is easier to apply windshield decal before this step. Place windshield flat on table, face up. Turn windshield wipers to the left. Remove backing from decal. Begin applying at left edge and work towards the center, moving the edges of the windshield wipers down as you go.

G ACCESSORIES

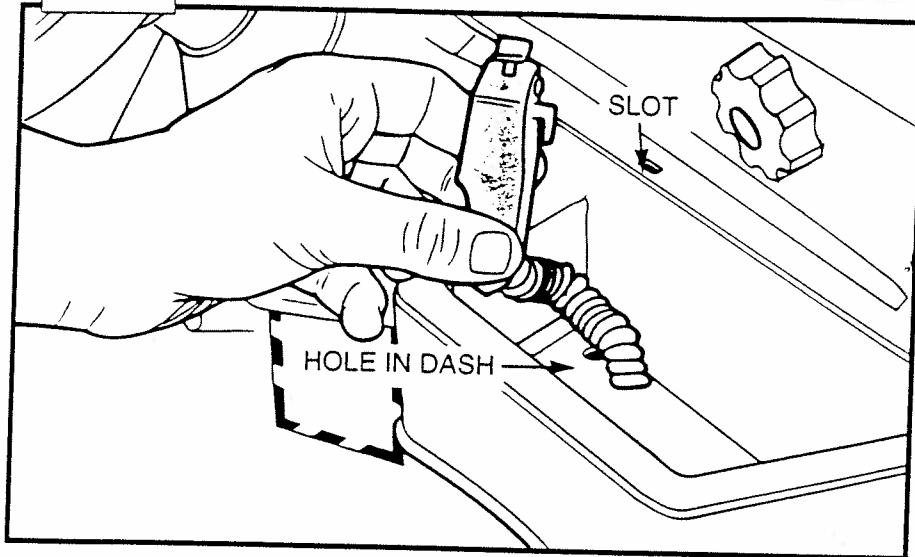

1

INSERT microphone cord firmly into hole in dash. PULL back on cord to lock into place. HANG microphone on slot.

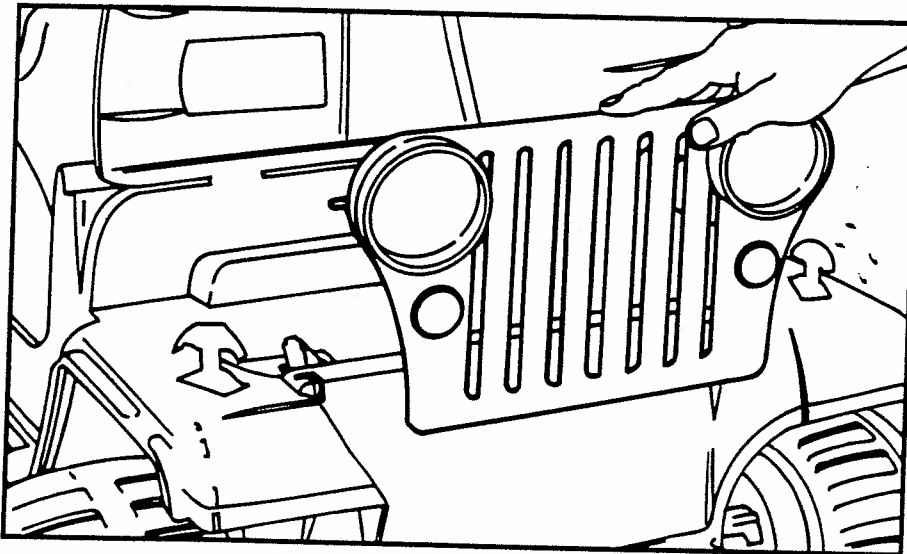

2

ALIGN tabs on grill with holes in body. PRESS into place

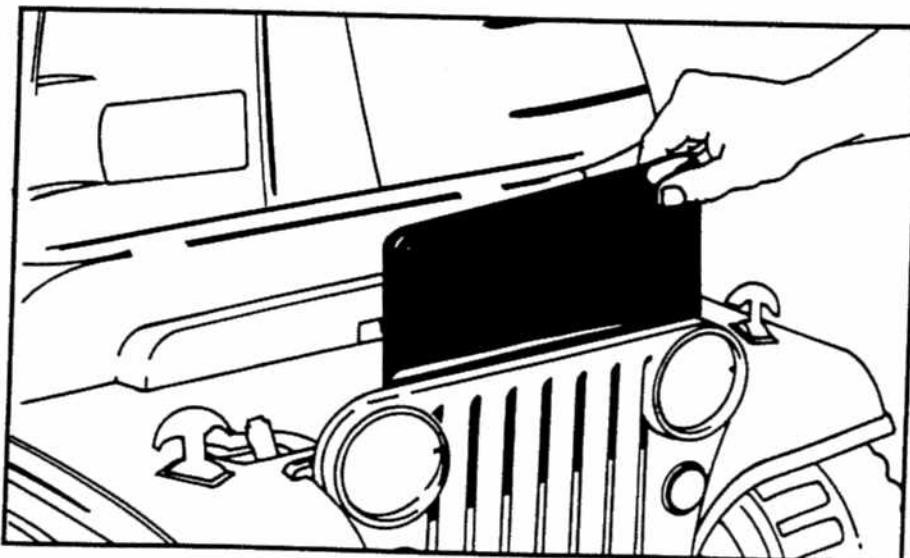

3

SLIDE radiator decal sheet between grill and front body.

H FRONT BUMPER / HEADLIGHT LENSES

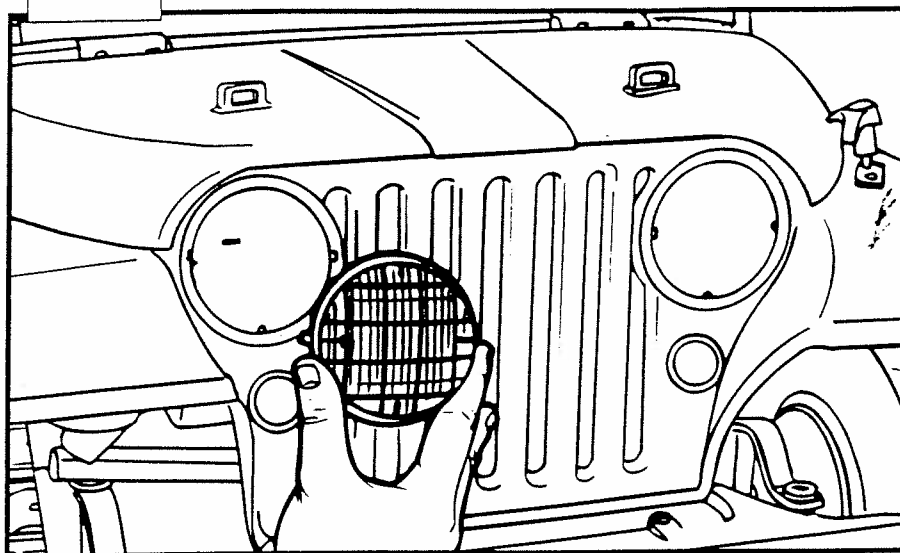

1

PLACE one tab of headlight lens into body. PUSH other tab into hole in body by gently pushing tab toward center of lens. REPEAT for other side.

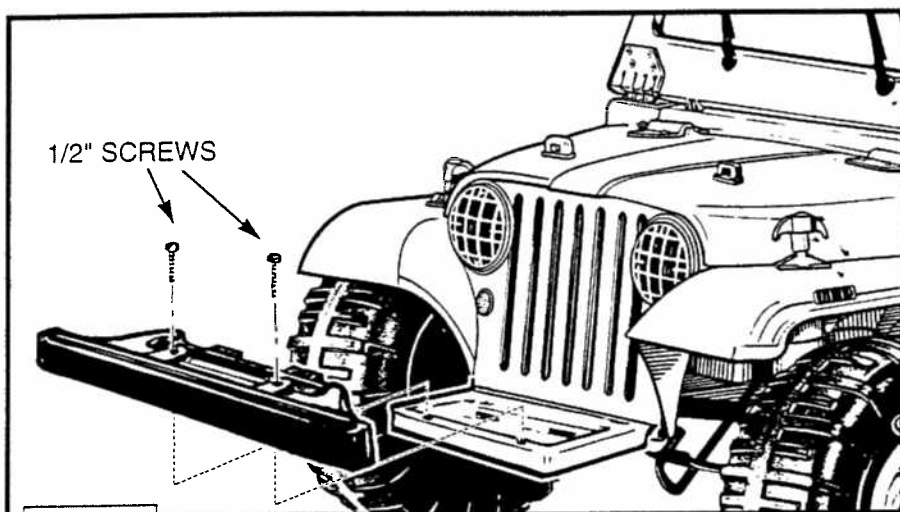

2

INSERT tabs on front of bumper into slots in body. INSERT two 1/2" screws through bumper into body. TIGHTEN.

I DECALS

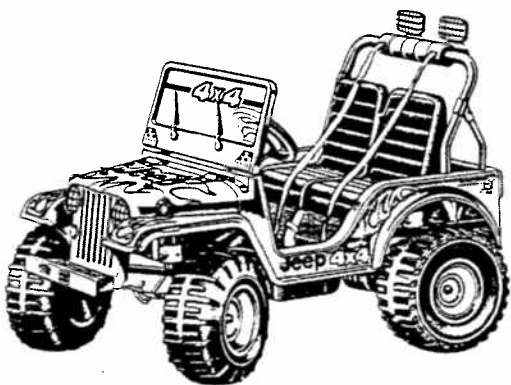

PROPER DECAL APPLICATION WILL KEEP THE DECALS LOOKING THEIR BEST!

WASH your hands before applying decals.
WIPE the vehicle with a soft dry cloth to remove dust.
REMOVE decal from backing sheet.
ALIGN decal in desired position.
LAY down one edge of decal, then slowly lay down the rest of the decal rubbing toward the center as you go.
After decal is in position,
RUB the decal firmly with the cloth to be sure adhesive is in firm contact.

J

BATTERY INSTALLATION

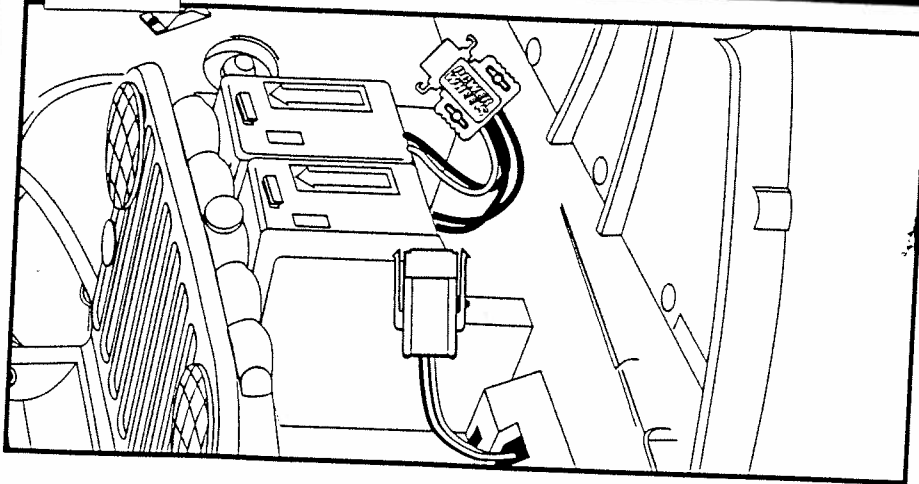

1

OPEN hood.
PLACE batteries in
compartment.

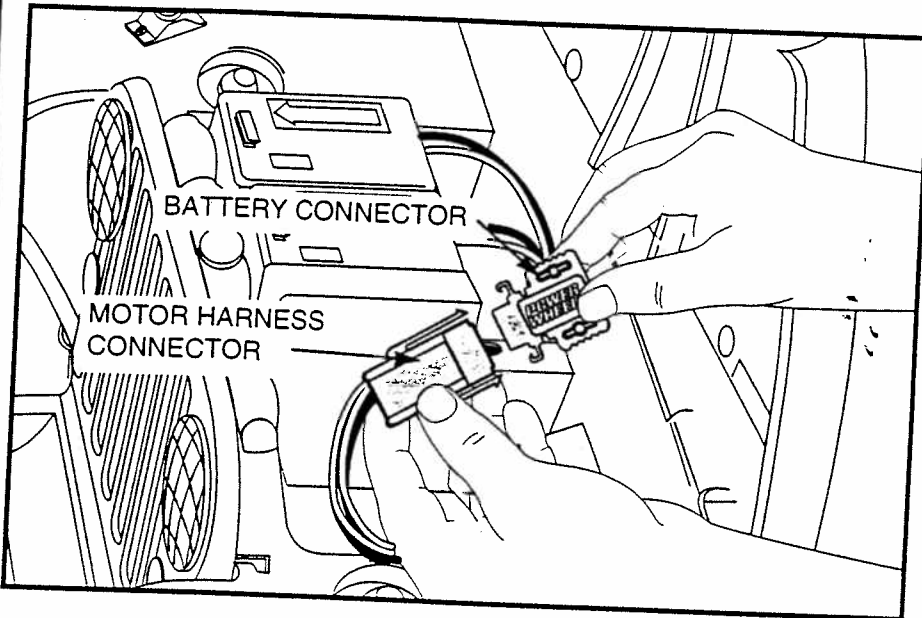

2

SQUEEZE tabs on motor
harness and push into battery
connectors to lock in.

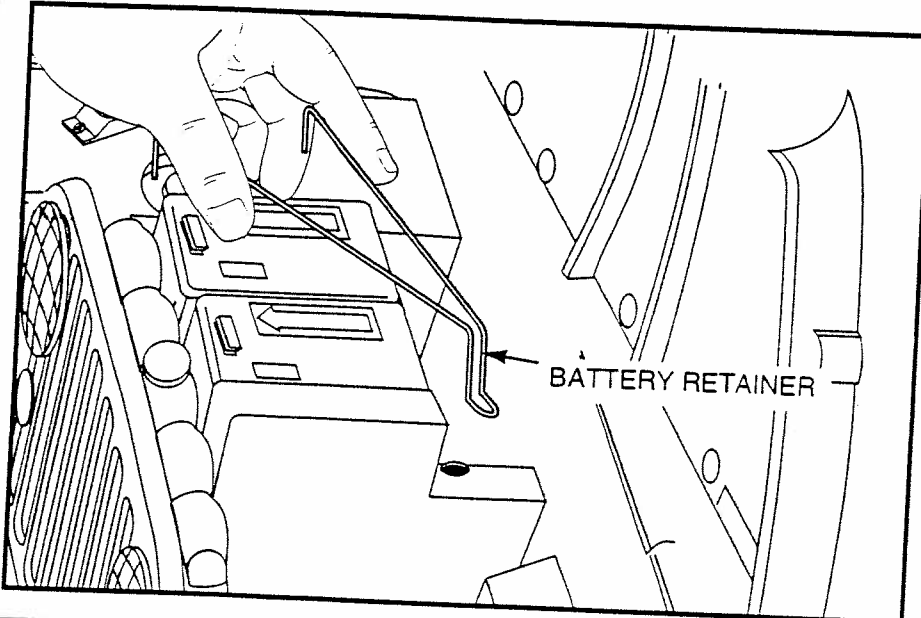

3

INSERT ends of battery
retainer into holes in body.

4

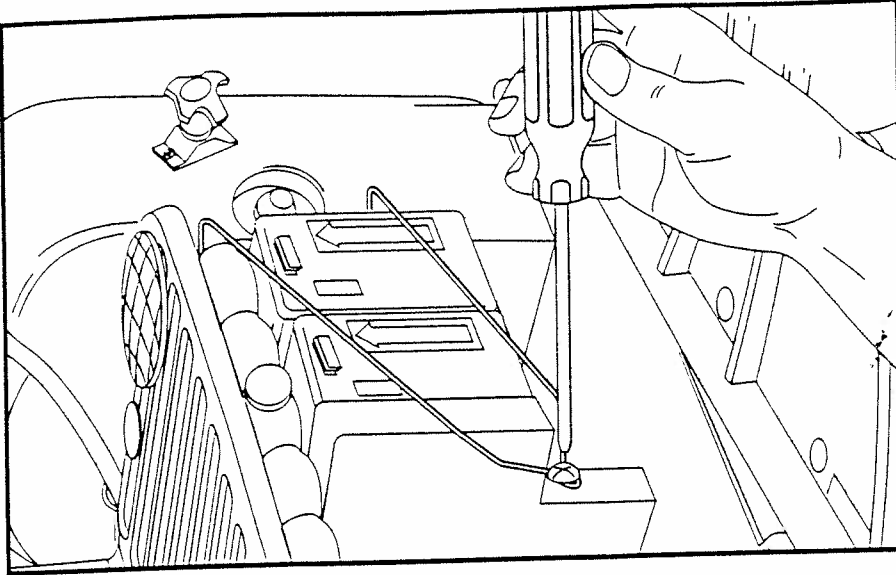

REPLACE 1" screw
(with sharp point) in battery
retainer.
CLOSE hood.

IMPORTANT
Carefully read your Owner's Manual for important safety messages
and operating instructions before using your vehicle.

REMEMBER
THE FIRST TIME . . .
Charge the batteries for a minimum of 18 hours.
AFTER THAT . . .
Charge the batteries a minimum of 14 hours.

HIGH-SPEED CONNECTION
Your vehicle is now ready to go.
For safety reasons, it will only operate
in low speeds.
To connect high-speed see
Owner's Manual.

OWNER'S MANUAL

**SUPER SOUND
JEEP 4X4** **POWER
WHEELS**



PLEASE READ THIS MANUAL AND KEEP IT
FOR FUTURE REFERENCE
This manual contains important information
that you will need to reference.
Please be sure to take your sales receipt.

IF YOU HAVE QUESTIONS OR NEED ASSISTANCE,
PLEASE CALL TOLL-FREE:
POWER WHEELS CUSTOMER SERVICE
1-800-348-0751
Trained Customer Service Representatives
are available to take your call in
English or Spanish.
Este manual también
disponible en español.



SUPER SOUND JEEP® 4X4

FOR MODELS AO4540 / 74540-9993

Mattel Power Wheels
Fort Wayne, Indiana

JEEP and the Jeep grille design are registered trademarks of CHRYSLER CORPORATION U.S.A. and are used under license.

© CHRYSLER CORPORATION 1995

Goodyear is a trademark of The Goodyear Tire & Rubber Company used with permission.

Champion and logo are registered trademarks of Cooper Industries, Inc.

© 1995 Fisher-Price Inc. All Rights Reserved

CAUTION: Electric vehicle not recommended for children under 3 years of age. As with all electrical products, precautions should be observed during handling and use to prevent electrical shock.



CHARGER: TYPE H INPUT: 120 VAC 60 HZ 28W
OUTPUT: 12 VDC 1200 mA

P/N 80037-0356